



GYC Club Races
May - October 2021
Genesee Yacht Club
Rochester, New York, USA

Final NOTICE OF RACE 5/27/2021

NOTE for 2021 change 8.4.2 *Boats in the Tuesday spinnaker divisions will receive zero points toward the division championship award for non-Tuesday races if they sail in a genoa division when there is a spinnaker division available. They will receive calculated points for racing in a genoa division if there is no spinnaker division available. to 8.4.2 Boats in the Tuesday spinnaker divisions will receive zero points toward the division championship award for non-Tuesday races if they sail in a genoa division when there is a spinnaker division available with the exception of single or double handed races. They will receive calculated points for racing in a genoa division if there is no spinnaker division available.*

1 RULES

- 1.1 The Genesee Yacht Club (GYC) Club Races will be governed by the rules as defined in The Racing Rules of Sailing (RRS).
- 1.2 Class Rules of PHRF-Lake Ontario (LO) shall apply.

2 ELIGIBILITY AND ENTRY

- 2.1 Members of Genesee Yacht Club, in good standing, will be eligible to enter a boat in any club race and a member of the club must be aboard during the race. Other boats may enter with prior approval of the Rear Commodore or his/her delegate on a race by race basis.
- 2.2 Eligible boats must enter by completing Appendix A, 2021 GYC Intention-to-Race Form and paying the PHRF Fee as prescribed in Appendix A on or before Sailor's Night, May 4, 2021.

3 SCHEDULE

- 3.1 Registration: from March 23 through Sailor's night, May 11, 2021.
- 3.2 Dates, starting times, and where applicable, the number of races for a Series Race as follows:
 - 3.2.1 Spring Tuesday Series
 - 3.2.1.1 Dates: 6/1, 6/8, 6/15, 6/22, 6/29, 7/6
 - 3.2.1.2 First start time: 1830, rolling 5-minute starts
 - 3.2.1.3 VHF radio competitors' announcement approximately 5 minutes before the first scheduled start
 - 3.2.2 Summer Tuesday Series
 - 3.2.2.1 Dates: 7/13, 7/20, 7/27, 8/3, 8/10, 8/17

- 3.2.2.2 First start time: 1830, rolling 5-minute starts
- 3.2.2.3 VHF radio competitors' announcement approximately 5 minutes before the first scheduled start
- 3.2.3 Fall Tuesday Series
 - 3.2.3.1 Dates: 8/24, 8/31, 9/7, 9/14, 9/21
 - 3.2.3.2 First Start August races: 1830, rolling 5-minute starts
 - 3.2.3.3 First Start September races: 1800, rolling 5 minute starts
 - 3.2.3.4 VHF radio competitors' announcement approximately 5 minutes before the first scheduled start
- 3.2.4 Spring Weekend Series
 - 3.2.4.1 Dates: 6/5, 6/12
 - 3.2.4.2 Number of Races: 2 per day, 4 total
 - 3.2.4.3 First Start: 1000
 - 3.2.4.4 Skippers meeting 0900
- 3.2.5 Double Handed Series
 - 3.2.5.1 Dates: 7/24, 8/7, 8/21
 - 3.2.5.2 Number of Races: 2 per day, 6 total
 - 3.2.5.3 First Start: 1000
 - 3.2.5.4 Skippers meeting at 0900
 - 3.2.5.5 Number of crew: boats less than 30': 2, boats 30' or greater may have 2 or 3 crew.
- 3.2.6 Fall Weekend Series
 - 3.2.6.1 Dates 9/18, 9/25
 - 3.2.6.2 Number of Races: 2 per day, 4 total
 - 3.2.6.3 First Start: 1000
 - 3.2.5.4 Skippers meeting at 0900
- 3.2.7 Single Handed Race
 - 3.2.7.1 Date 9/4
 - 3.2.7.2 Number of Races: One
 - 3.2.7.3 First Start: 1000
 - 3.2.7.4 Skippers meeting at 0900
- 3.2.8 Long Distance Series
 - 3.2.8.1 Dates 5/29, 6/19, 7/17
 - 3.2.8.2 Number of Races: 3
 - 3.2.8.3 First Start: 1000
 - 3.2.7.4 Skippers meeting at 0900
- 3.2.9 Fall Weekend Regatta
 - 3.2.9.1 Date 10/2
 - 3.2.9.2 Number of Races: 3
 - 3.2.9.3 First Start: 1000
 - 3.2.9.4 Skippers meeting at 0900
 - 3.2.9.5 Latest time for warning signal of last race: 1300

4 SAILING INSTRUCTIONS

4.1 The sailing instructions will be available on or before May 8, 2021.

5 THE COURSES

5.1 The courses to be sailed will be as follows, note new S course:

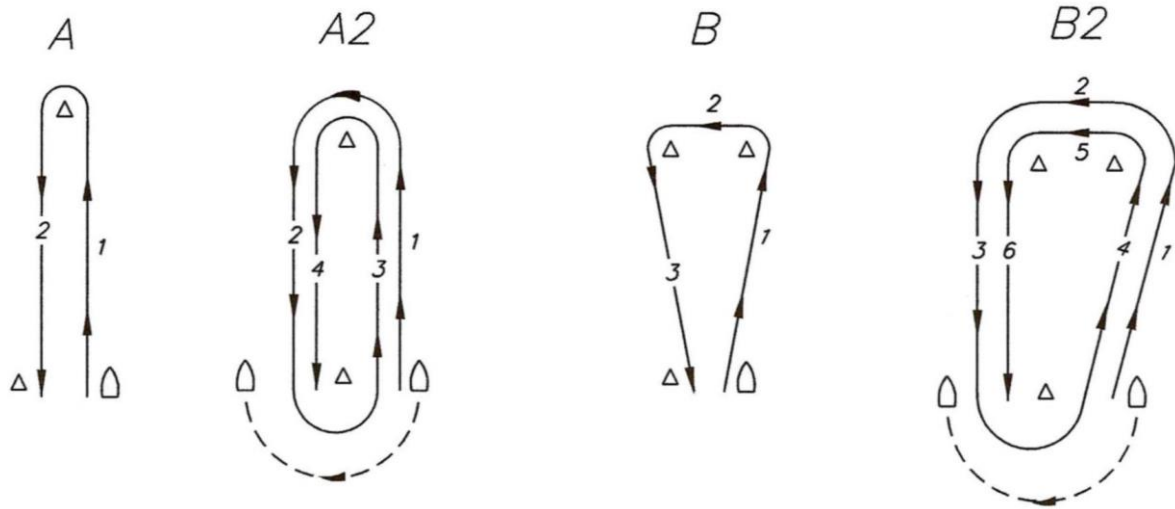

C, C2



D, D2

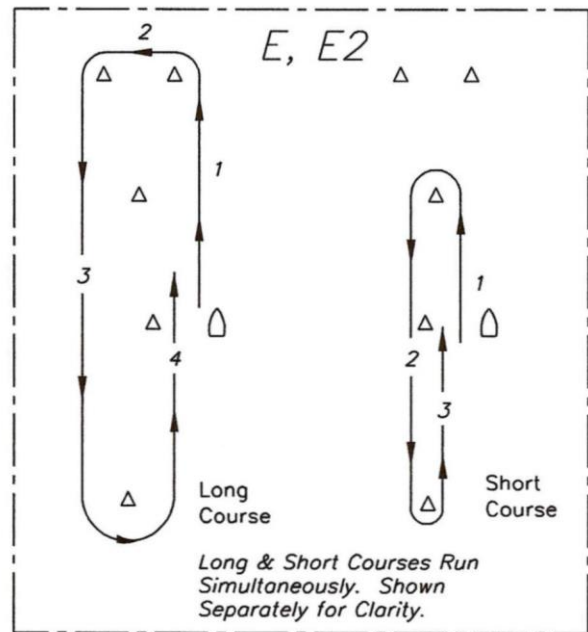
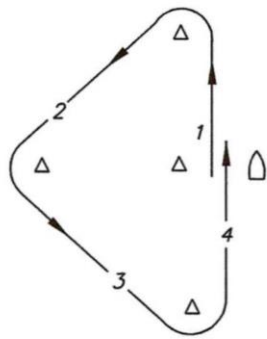

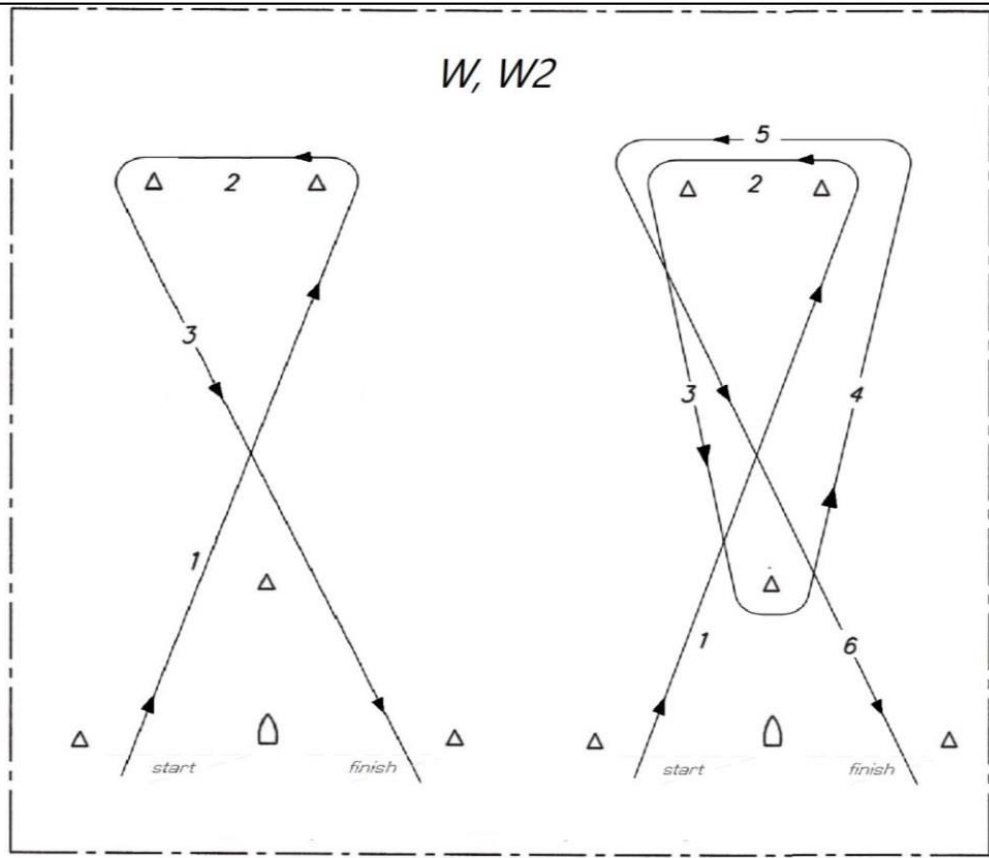
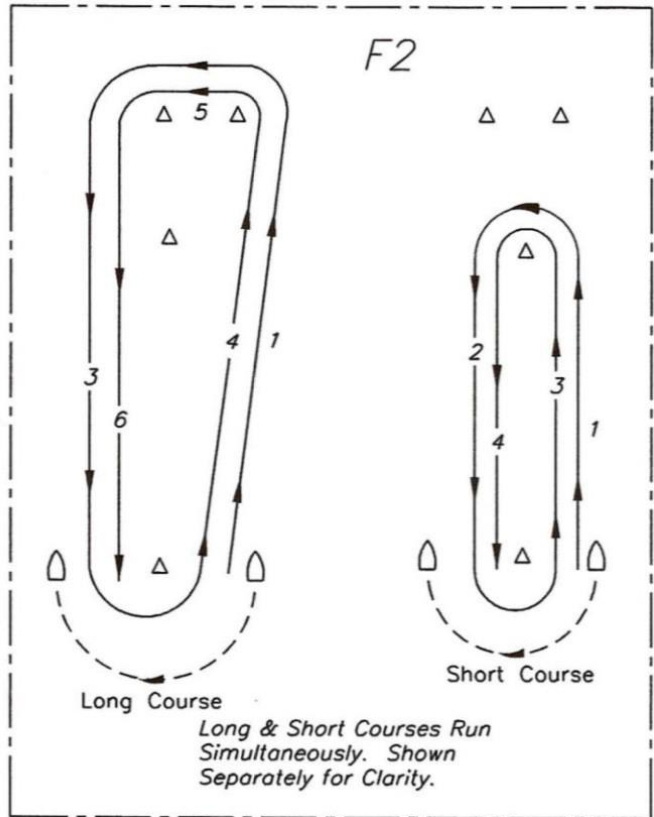
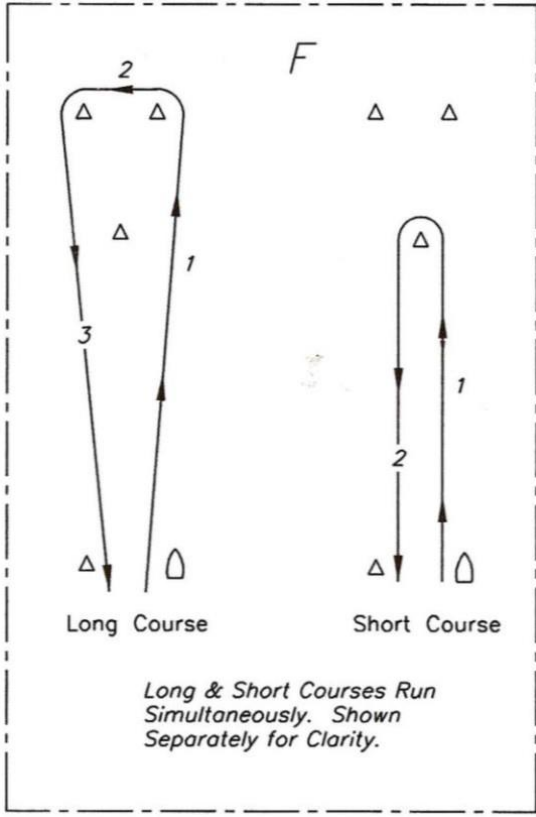

New S Course

S

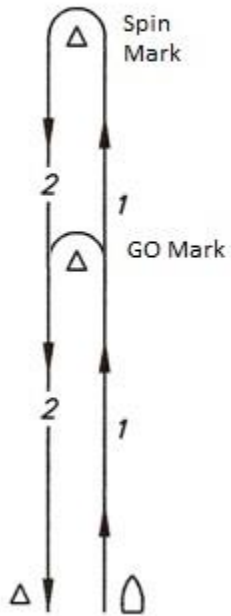

6 RADIO COMMUNICATION

6.1 Except in an emergency, a boat that is racing shall not make voice or data transmissions and shall not receive voice or data communication that is not available to all boats.

7 SCORING

7.1 Appendix A, Racing Rules of Sailing are used for scoring unless otherwise specified.

7.2 EXCLUSION TABLE

7.2.1 Where specified series exclusions will be based on the following table:

Number of Races	Number of Excluded Races
1	0
2	0
3	1
4	1
5	1
6	1
7	2
8	2
9	2
10	3
11	3
12	3
More than 12	4

8 PRIZES

8.1 SERIES CHAMPIONSHIP

8.1.1 Flags will be awarded to the top 3 places in each division. Only the scores for non-excluded races will be used.

8.2 TUESDAY SERIES DIVISION CHAMPIONSHIPS

8.2.1 Trophies will be based on all Tuesday races for the year as a series, Tuesday division championship trophies will be awarded to the first-place boat.

8.2.2 Only the scores for non-excluded races will be used.

8.3 TUESDAY NIGHT OVERALL CHAMPIONSHIP

8.3.1 Trophies will be based on all Tuesday races for the year as a series, the overall Tuesday Club Championship Trophy will be awarded to the first-place spinnaker boat scoring all spinnaker divisions together as one division on corrected times.

8.3.2 Only the scores for non-excluded races will be used.

8.4 DIVISION CHAMPIONSHIPS

8.4.1 The division championship awards will be calculated on all races within the following series with no exclusions:

1. Spring Tuesday Series

2. Summer Tuesday Series
3. Fall Tuesday Series
4. Spring Weekend Series
5. Double Handed Series
6. Fall Weekend Series
7. Single Handed Race
8. Long Distance Series
9. Fall Weekend Regatta

The award will be based on each Tuesday night division. The score for each boat will be a summation of the modified high point score as defined in 8.4.5 for all races within each qualifying series.

8.4.2 Boats in the Tuesday spinnaker divisions will receive zero points toward the division championship award for non-Tuesday races if they sail in a genoa division when there is a spinnaker division available with the exception of single or double handed races. They will receive calculated points for racing in a genoa division if there is no spinnaker division available.

8.4.3 Boats in the Tuesday genoa divisions will receive calculated points if they elect to sail in a spinnaker division in non-Tuesday races.

8.4.4 Boats who elect to change Tuesday division during the season will not be eligible for a division championship award.

8.4.5 Race Scores for the division championship award will be determined as follows:
Define 'N' to be the number of boats competing in a particular race including boats receiving zero points.

Define P as the place assigned by low point scoring.

Each boat who comes to the starting line will be scored using the following formula rounded to 2 decimal places:

$$(N+1-P)/N$$

For example,

1st place finish: $(N+1-P)/N (=1.0)$

Each place thereafter receives a smaller fraction score.

The last place boat who completed the course will have a score greater than zero.

A boat which is DNS, DNF or was DSQ will receive a score of 0 by this formula.

Boats that do not compete in that race (DNC) will not be scored.

Example scores:

boats (N) = 3	
Place Finish	High Point Score
1	1.00
2	0.67
3	0.33

boats (N) = 5	
Place Finish	High Point Score
1	1.00
2	0.80
3	0.60
4	0.40
5	0.20

boats (N) = 7	
Place Finish	High Point Score
1	1.00
2	0.86
3	0.71
4	0.57
5	0.43
6	0.29
7	0.14

boats (N) = 9	
Place Finish	High Point Score
1	1.00
2	0.89
3	0.78
4	0.67
5	0.56
6	0.44
7	0.33
8	0.22
9	0.11

8.5 BOAT OF THE YEAR

8.5.1 The trophy will be awarded to the GYC spinnaker boat with the most first places in all GYC sponsored events excluding Pizza or “Fun” races.

8.5.2 The Races included in this determination are:

1. Spring Tuesday Series
2. Summer Tuesday Series
3. Fall Tuesday Series
4. Spring Weekend Series
5. Double Handed Series
6. Fall Weekend Series
7. Single Handed Race
8. Long Distance Series
9. Fall Weekend Regatta

8.6 DOUBLE-HANDED SERIES TROPHY

8.6.1 Based on all Double-Handed races for the year as a series, the overall Double-Handed Series Championship Trophy will be awarded to the first place boat scoring all divisions together as one division on corrected times. Only the scores for non-excluded races will be used.

8.7 SINGLE HANDED RACE TROPHY

8.7.1 The overall Single-Handed Race Championship Trophy will be awarded to the first place boat scoring all divisions together as one division on corrected times.

9 DISCLAIMER OF LIABILITY

9.1 Competitors participate in the races entirely at their own risk. See RRS 4, Decision to Race. The organizing authority will not accept any liability for material damage or personal injury, or death sustained in conjunction with or prior to, during, or after GYC racing.

10 INSURANCE

10.1 Each participating boat shall be insured with valid third-party liability insurance with a minimum cover of \$300,000 USD per incident or the equivalent.

11 FURTHER INFORMATION

11.1 For further information please contact the GYC Rear Commodore, Matt Sanderson. Cell 585 519-7102 or email msanderson@rochester.rr.com.

Appendix A 2021 GYC Intention-to-Race Form

I, _____ intend to race in the GYC 2021 race season. Boat Name: _____

Boat Type (e.g. J80): _____ My Sail Number: _____

My Insurance provider is: _____ Policy #: _____

All participating boats are expected to support **Race Management for as many times as possible** during the season. All participating Tuesday night boats are also expected to **provide cook/cleanup services for the cookout**. Please go to Signupgenius at:

<https://www.signupgenius.com/go/508084caaa82ea5fa7-race>

and pick the date and time you and your crew can support the racing activities.

GYC Event	Fleet
I intend to race in the Spring Tuesday night series	<input type="checkbox"/> GO or <input type="checkbox"/> SPIN
I intend to race in the Summer Tuesday night series	<input type="checkbox"/> GO or <input type="checkbox"/> SPIN
I intend to race in the Fall Tuesday night series	<input type="checkbox"/> GO or <input type="checkbox"/> SPIN
I intend to race in the Spring Sprints Regatta	<input type="checkbox"/> GO or <input type="checkbox"/> SPIN
I intend to race in the Long Distance Series	<input type="checkbox"/> GO or <input type="checkbox"/> SPIN
I intend to race in the Spring Weekend Series	<input type="checkbox"/> GO or <input type="checkbox"/> SPIN
I intend to race in the Double Handed Weekend Series	<input type="checkbox"/> GO or <input type="checkbox"/> SPIN
I intend to race in the Single Handed Race	<input type="checkbox"/> GO
I intend to race in the Fall Weekend Series	<input type="checkbox"/> GO or <input type="checkbox"/> SPIN
I intend to race in the Catchup Race	<input type="checkbox"/> GO
I intend to race in the Fall Regatta	<input type="checkbox"/> GO or <input type="checkbox"/> SPIN

I hereby certify that I have the minimum equipment as suggested in the Genesee Yacht Club 2021 Sailing Instructions. I enter into GYC racing of my own free will. I also agree that the Genesee Yacht Club is not responsible for any injury or loss to persons or property that may occur as a result of participation in the 2021 GYC Racing Program. Further, I believe my yacht is well found for racing, and I certify that I carry adequate liability insurance coverage for collision and bodily injury. I have a valid PHRF certificate. I understand and agree to be bound by The ISAF Racing Rules of Sailing and all other rules that govern these events. The Genesee Yacht Club Race Committee reserves the right to reject any yacht.

Signature of Owner: _____ Date: _____

Signature of Skipper (if different): _____ Cell Phone: _____

Note: No boat will be scored until completed ITR forms have been received and PHRF dues have been paid!

Invoice **Due Date: On or before Sailor's Night**

2021 Lake Ontario PHRF Fee including tax. \$35.00

Checks should be made out to GYC and placed in the drawer or may be returned to:

Treasurer: Linda Barton, GYC PO Box 12771 Rochester, NY 14612 or

Rear Commodore: Matt Sanderson, 5099 Lima Road, Geneseo, NY 14454